

MC36C



Compact safety magnetic sensors



Description

The MC36C series are encoded safety magnetic sensors with compact housing used to monitor the position of hinged, sliding or removable guards of industrial applications.

Carlo Gavazzi safety sensors stop or disconnect the dangerous motions, if the mobile protections are opened or displaced. They are suitable for safety gates applications up to safety category 4, PLe according to EN ISO 13849-1 with suitable logic safety module.

MC36C sensors are the right answer in harsh industrial environments with damp and dusty condition.

Benefits

- **Standards compliance.** Up to Cat. 4 PL e in accordance with EN ISO 13849-1.
- **Customizable.** The sensors are available with left or right exit, integrated cable or M8 connection and optionally LED indicator.
- **High performance.** Reinforced polymeric casing (PBT) with a protection degree IP67, operating temperature range from -25°C to +80°C.
- **Compact dimensions.** Only 36 x 26 x 13 mm
- **Different outputs.** 2NO or 1NO + 1NC. (The status of the output is intended without the actuator)
- **Approvals** by CE, cULus

Applications

The safety magnetic sensors together with the magnetic actuator are particularly suitable to monitor protections of the safety gates that allow the entry to machines with dangerous movements, mainly in environment with strong presence of dust and dirtiness.

When connected to a safety module, the system can reach safety category up to category 4, PL e (EN ISO 13849-1).

Main functions

- Actuation without mechanical contact for high durability in all environmental conditions.
- Sensors are completely sealed and so insensitive to dirt and dust.
- Compact dimensions together with all mechanical variant possibilities allow very high flexibility in the installation.
- Suitable for applications with large tolerances or where mechanical features may change over the time, thanks to the wide actuation range.

References

Order code



MC36CH



Enter the code option instead of

Code	Option	Description	Note
M	-	Magnetic	
C	-	Compact rectangular size	
36	-	36mm length	
C	-	Plastic	
H	-	Reed contact	
<input type="checkbox"/>	20	Contacts: 2 normally open	With open guard
<input type="checkbox"/>	101C	Contacts: 1 normally open and 1 normally closed	With open guard
<input type="checkbox"/>	L	Left exit	
<input type="checkbox"/>	R	Right exit	
<input type="checkbox"/>	A2	Connection type: PVC cable 2m	
<input type="checkbox"/>	M5	Connection type: M8 integrated connector	
<input type="checkbox"/>	Null	No LED	
<input type="checkbox"/>	L	With LED indicator	

Magnetic actuator



MC36CM

 Type selection

Left exit



Connection	Output type	LED	Ordering no.
PVC cable 2m	2NO	No	MC36CH2OLA2
		Yes	MC36CH2OLA2L
	1NO + 1NC	No	MC36CH1O1CLA2
		Yes	MC36CH1O1CLA2L
M8 integrated connector	2NO	No	MC36CH2OLM5
		Yes	MC36CH2OLM5L
	1NO + 1NC	No	MC36CH1O1CLM5
		Yes	MC36CH1O1CLM5L

Right exit



Connection	Output type	LED	Ordering no.
PVC cable 2m	2NO	No	MC36CH2ORA2
		Yes	MC36CH2ORA2L
	1NO + 1NC	No	MC36CH1O1CRA2
		Yes	MC36CH1O1CRA2L
M8 integrated connector	2NO	No	MC36CH2ORM5
		Yes	MC36CH2ORM5L
	1NO + 1NC	No	MC36CH1O1CRM5
		Yes	MC36CH1O1CRM5L

Structure

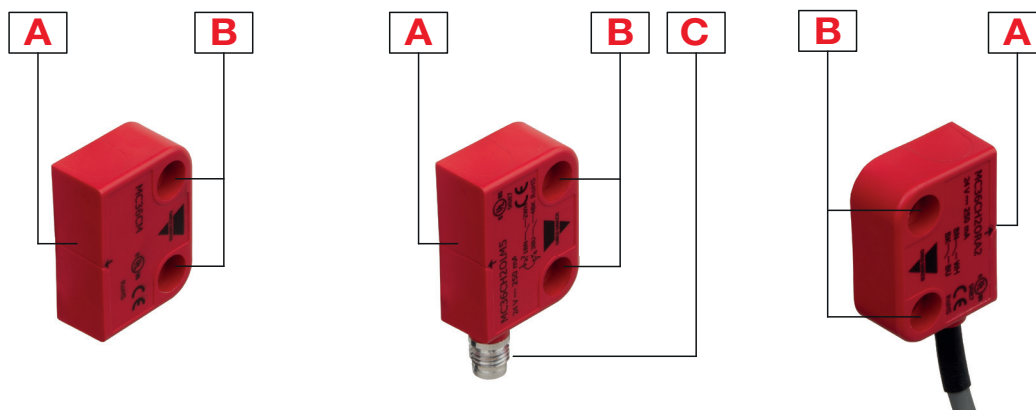

Element	Component
A	Sensing face
B	Screw hole
C	M8, 4 pin, male connector

Dimensions [mm]

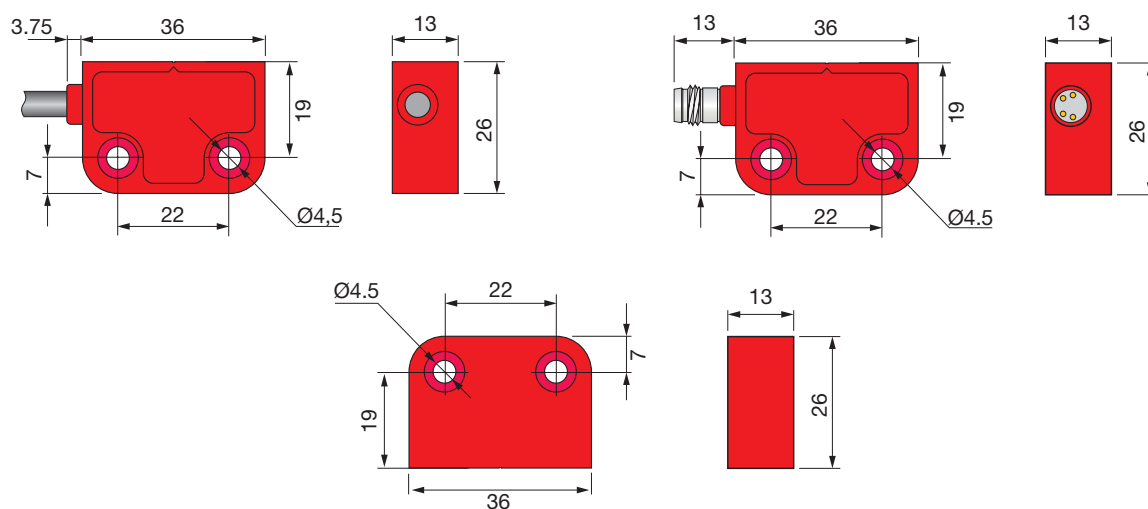

Sensing

Detection

Assured switching distance (S_{ao})	5mm with actuator MC36CM
Assured switch-off distance (S_{ar})	15mm with actuator MC36CM
Minimum distance between two sensors	50 mm

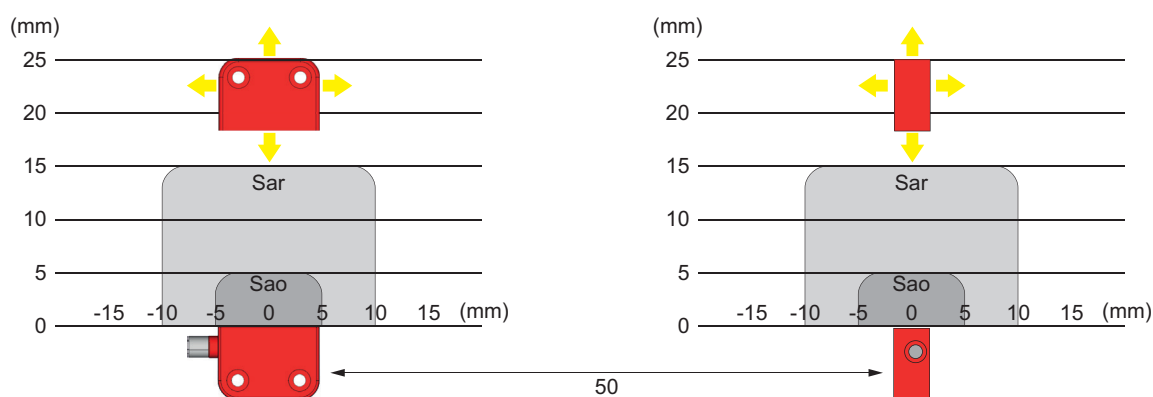

Note: the typical detection characteristic shown may vary from sensor to sensor.

Accuracy

Repeat accuracy (R)	$\leq 10\%$
----------------------------	-------------

Features

Outputs

LED indication	Yellow (optional)
Type	2NO, 1NO+1NC, Reed contact
Rated operating voltage (U_e)	12-24 Vac/dc
Rated operating current (I_e)	0.25 A (resistive load)
Max switching load	6 W (resistive load)
Thermal current I_{th}	0.25 A
Rated insulation voltage U_i (IEC EN 60947-1)	120 Vac (with cable) 60 Vac / 75 Vdc (with M8 connector)
Rated impulse withstand voltage U_{imp}	6 KV / 1.5 KV (with connector)
Protection class	III
Reverse polarity protection	Yes

Response times

Max. operating frequency (f)	100 Hz
Response time	< 10 ms

Environmental

Operating temperature	-25° to +80°C (-13° to +176°F)
Storage temperature	-25° to +80°C (-13° to +176°F)
Vibration resistance EN 60068-2-6	10 g (10...150 Hz)
Shock resistance EN 60068-2-27	30 g (11 ms)
Degree of protection EN 60529	IP67
Pollution degree IEC 60947-5-1	3

Mechanical data

Housing material	PBT red
Weight	35 to 75g
Max torque for M8 version	1.5 Nm





- Use non-magnetic screw only.
- Fasten steadfastly the sensor and the actuator to the safety device (by means of rivets, tamper-proof screws, etc.).
- Fasten the sensor on plane surfaces only, in order to avoid possible distortions that could damage the sensor or alter switching distances.
- To activate the safety sensors it is necessary to use the proper coded actuator MC36CM. Conventional magnets cannot be used.
- The sensor and actuator central reference marks must be opposed and aligned.

Electrical connection

Connection type	2m PVC cable 4 x 0.25 mm ²
	M8 4-pin connector

Compatibility and conformity

Conforms to the standards	EN/IEC 60947-5-1
Conforms to the directive	2006/42/CE Machinery Directive 2014/30/EU Electromagnetic Compatibility Directive 2011/65/UE RoHS Directive
Performance level (PL)	PL e - according to EN ISO 13849-1*
Safety category	Up to 4 - according to EN ISO 13849-1*
Terminal marking	In accordance with IEC 60947-5-1
B10d for each channel	700.000 operations (@ 250mA resistive load) Mechanical endurance: 80 millions operations
Approvals	 

* When connected to a safety module

Connection Diagrams

Cable version

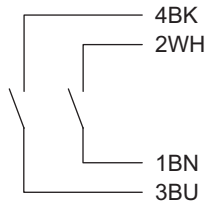

Fig. 1 2 NO (without LED)

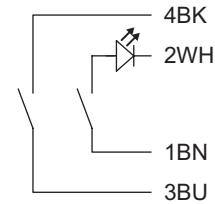

Fig. 2 2 NO (with LED)

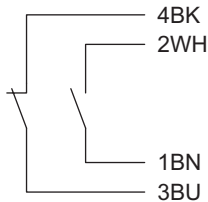

Fig. 3 1 NO + 1 NC (without LED)

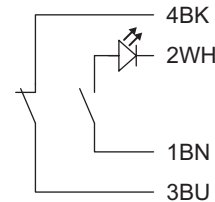

Fig. 4 1 NO + 1 NC (with LED)

Colour code			
BN: Brown	WH: White	BK: Black	BU: Blue

M8 connector version

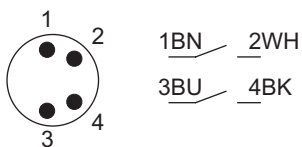

Fig. 5 2 NO (without LED)

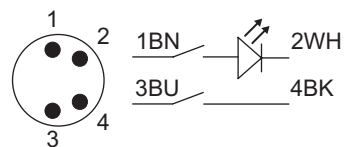

Fig. 6 2 NO (with LED)

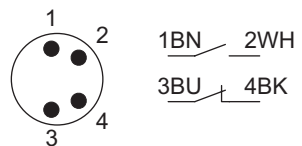

Fig. 7 1 NO + 1 NC (without LED)

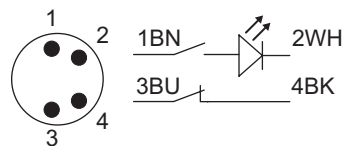

Fig. 8 1 NO + 1 NC (with LED)



COPYRIGHT ©2019
Content subject to change. Download the PDF: www.productselection.net

Mouser Electronics

Authorized Distributor

Click to View Pricing, Inventory, Delivery & Lifecycle Information:

[Carlo Gavazzi:](#)

[MC36CH1O1CLA2](#) [MC36CH1O1CLA2L](#) [MC36CH1O1CLM5](#) [MC36CH1O1CLM5L](#) [MC36CH1O1CRA2](#)
[MC36CH1O1CRA2L](#) [MC36CH2ORA2](#) [MC36CH2ORA2L](#) [MC36CH2ORM5](#) [MC36CH2ORM5L](#) [MC36CM](#)
[MC36CH1O1CRM5](#) [MC36CH1O1CRM5L](#) [MC36CH2OLA2](#) [MC36CH2OLA2L](#) [MC36CH2OLM5](#) [MC36CH2OLM5L](#)